

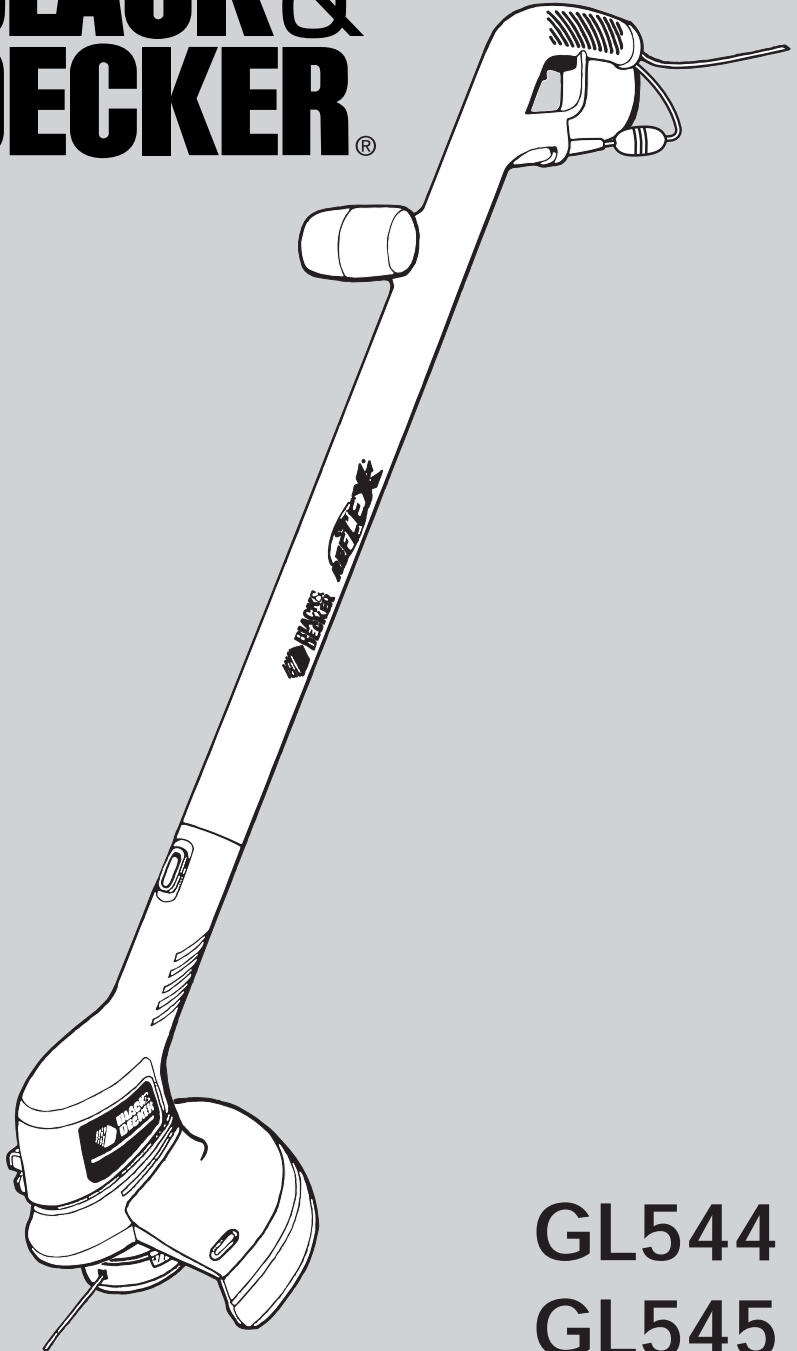

**BLACK &
DECKER®**



**GL544
GL545**



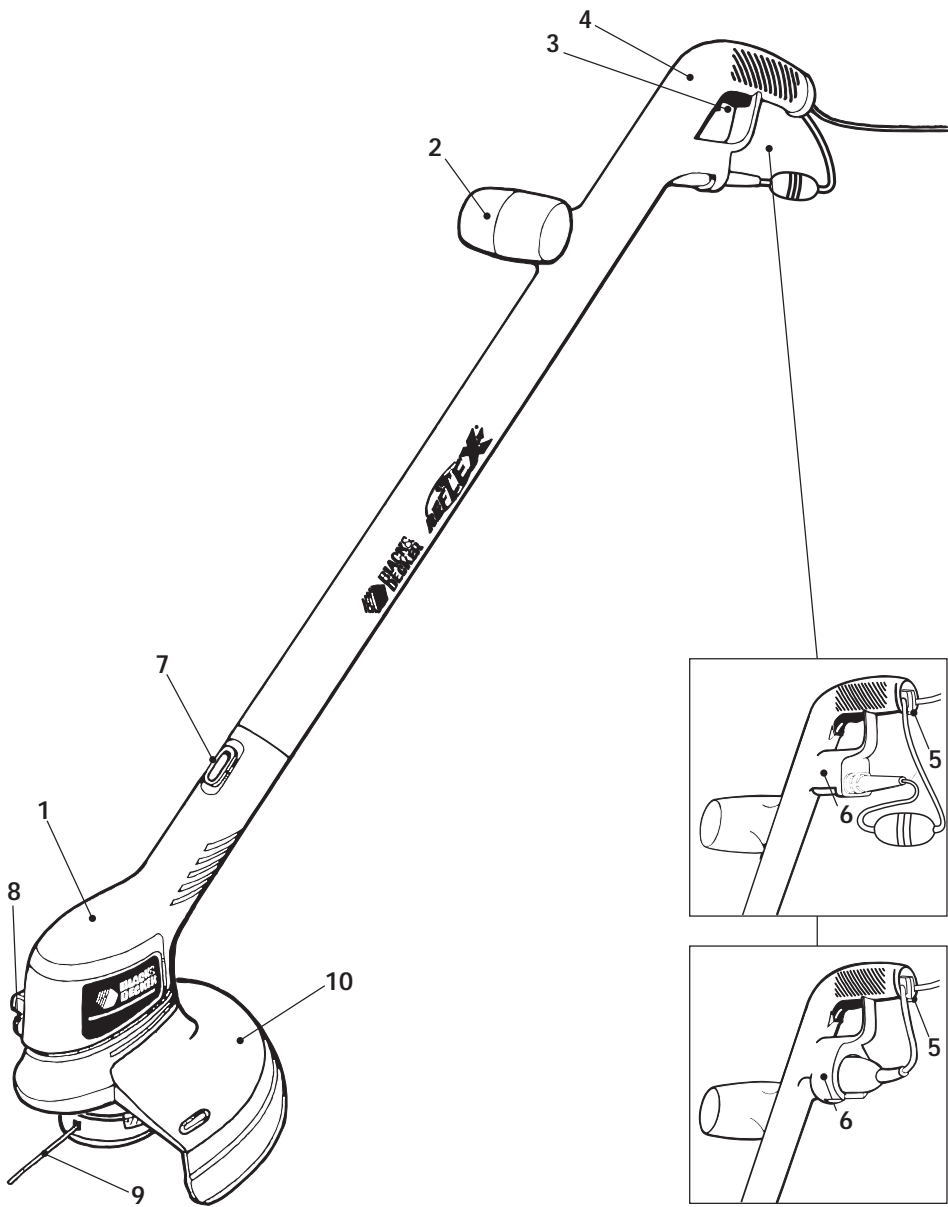

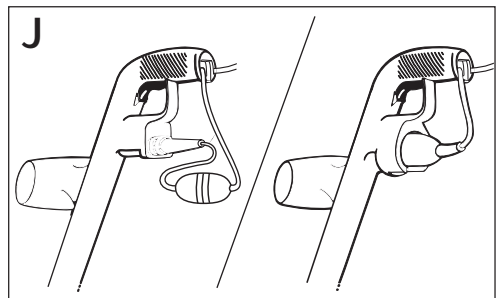
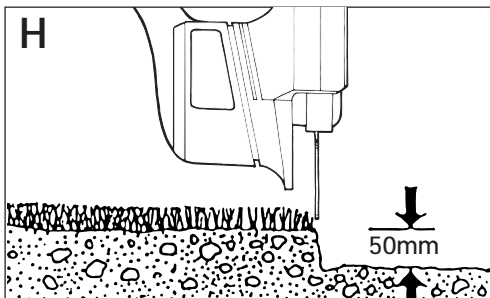
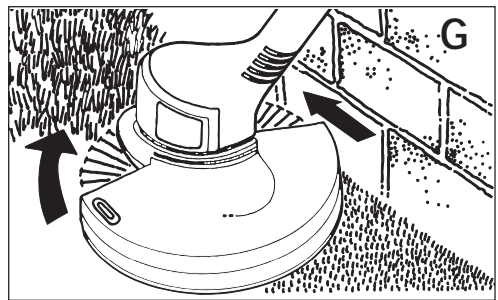
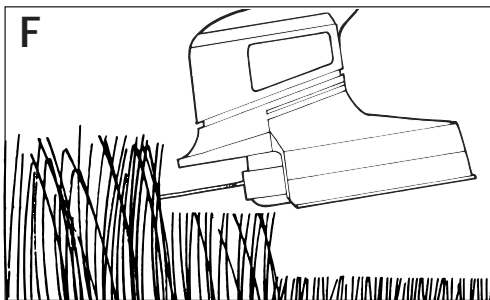
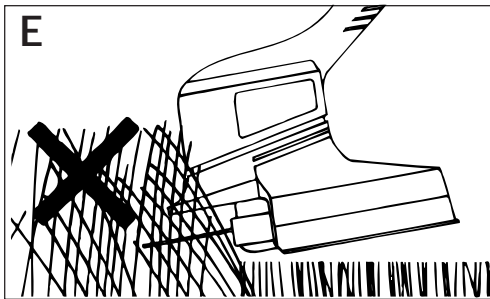
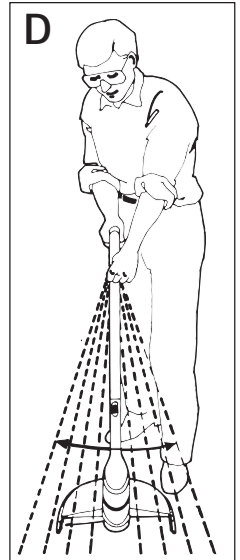
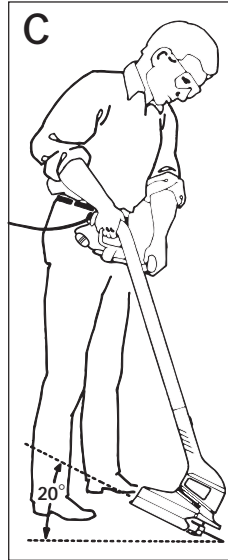
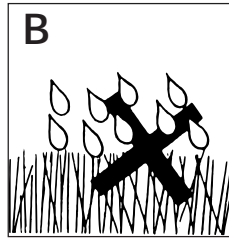
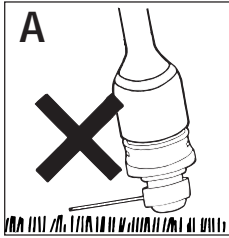
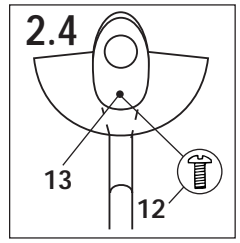
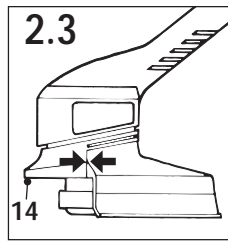
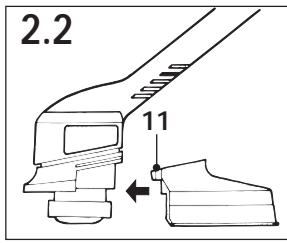
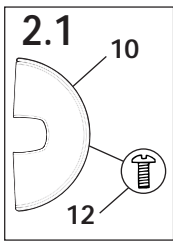

3.1

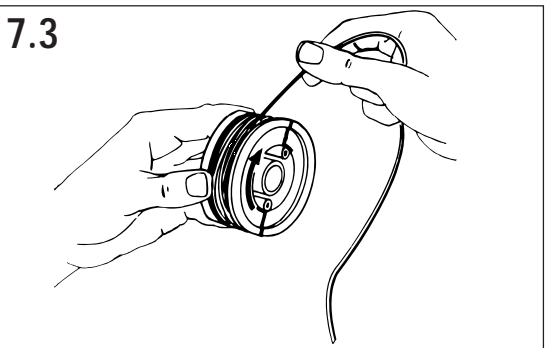
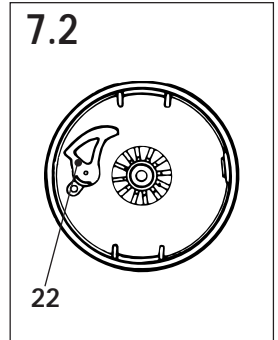
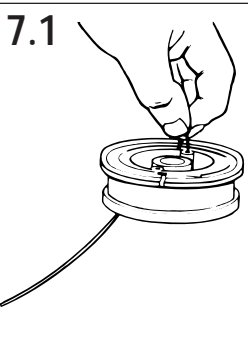
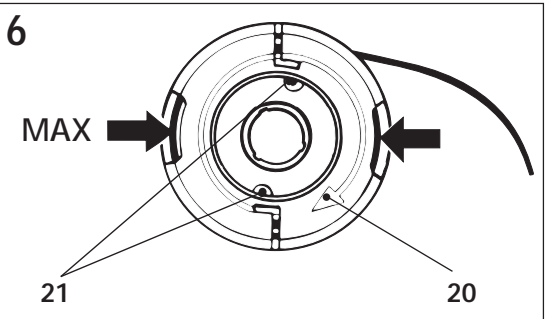
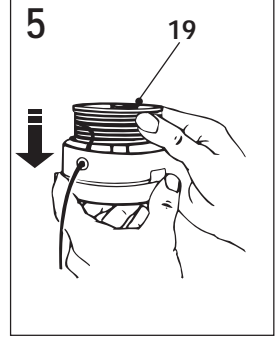
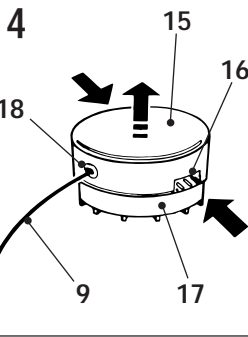
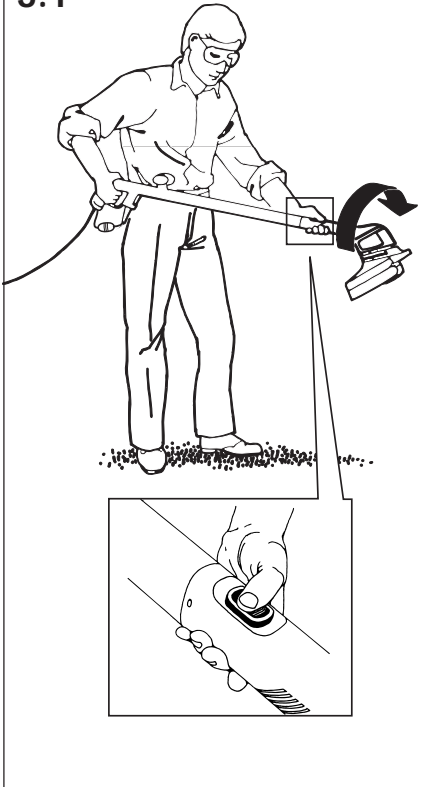

3.2



Congratulations!

Your purchase of this Black & Decker Reflex® grass trimmer and lawn edger assures you of years of problem free trimming. The Reflex® not only trims grass and edges the lawn, it also has a unique totally automatic line feed system. You do nothing - the Reflex® system means non-stop trimming: by the use of a simple mechanism it senses when the line has worn and, when needed, automatically feeds out line to its optimum cutting length. You just switch the unit on and trim.

Description

Following is a list of the parts that will be mentioned in this instruction leaflet and are shown in the appropriate diagrams:

- 1 Body (1)
Secondary handle (2)
Trigger switch (3)
Switch handle (4)
Supply cord restraint (5)
Power inlet or supply cord (6)
Edge conversion button (7)
Line trimming blade (8)
Cutting line (9)
Guard (10)
- 2 Guard retaining lugs (11)
Guard screw (12)
Guard screw hole (13)
Front edge (14)
- 4 Spool cover (15)
Spool cover tab (16)
Spool housing (17)
Eyelet (18)
Spool (19)
- 5
- 6 Arrow (20)
Line retaining hole (21)
- 7 Lever (22)

Safety instructions



Read all of this manual carefully, observing all the recommended safety instructions before, during and after using your machine. Maintain your machine in good working order.

Familiarise yourself with the controls on your machine before attempting to operate it, but above all, be sure you know how to stop your machine in an emergency.

Retain this manual and all other literature supplied with your machine for future reference.

Electrical connection

- Your machine is designed for use on AC (mains) electrical supplies only. Do not attempt to use on any other supply.
- Plug your machine into a power point, never in a light socket.
- Do not leave your machine unattended whilst it is connected to the electrical supply.
- Always switch off and remove the plug from the mains before cleaning, inspecting or adjusting any part of the trimmer, or if the supply cord has become damaged or entangled.



Double insulation



Your machine is double insulated. This means that all external metal parts are electrically isolated from the power supply. This is achieved by placing an extra insulation barrier between the electrical and mechanical parts. Double insulation means greater electrical safety and obviates the necessity of having the machine earthed.

Power supply cord

- The power supply cord should be regularly inspected for signs of damage or ageing and only used if in good condition.
- Always keep the power supply cord away from the cutting line (9), be aware of its position at all times.
- Never carry your machine by the cord or jerk the cord to remove the plug from the socket. Keep the cord away from heat, oils and sharp edges.
- Have damaged cords replaced completely by your nearest Black & Decker service centre. Do not attempt to do this yourself as the switch handle is not customer serviceable.

Cutting line

- Take care against injury from line trimming blade (8) during unpacking and assembly and any excess line which may be cut off when the trimmer is first operated.
- The cutting line (9) will continue to run for a short time after releasing the trigger switch. Under no circumstances should you attempt to stop the cutting line, always allow it to stop on its own.
- Never fit metal cutting line.



Clothing

- Always wear safety glasses when using your machine.
- To protect your feet, always wear stout shoes or boots (not bare footed or wearing open sandals).
- Wear long trousers to protect your legs - any debris left on the lawn or cutting path may be picked up and ejected by the cutting line.
- Use ear protection if the sound level seems uncomfortable when using your machine.



Using your machine

- Always use your machine in the manner outlined in this manual. Your machine is designed to be used in an upright position and if it is used in any other way an injury may result.
- Before using your machine, disconnect it from the electrical supply and visually inspect the rotating parts for damage. Also, check that the spool assembly is secure.
- Always check that your lawn or cutting path is clear of all sticks, stones, wire and other debris. Contact with such debris may damage your machine.
- Keep your machine away from your feet and other parts of your body when switching on and during operation.
- Do not switch on your machine when it is upside down.
- Walk, never run with the unit.
- Do not use your machine in the rain and do not allow it to get wet.
- Use your machine only in daylight or good artificial light.
- Do not cross gravel paths or roads whilst the cutting line is rotating.
- Do not cut excessively steep slopes. Be sure of your footing and cut across the face of slopes, never up and down.



- Never use your machine with a damaged guard (10) or without the guard fixed in position.
- Be careful when trimming as freshly cut grass is damp and slippery.

Safety of others

- Remember that the operator/user is responsible for accidents or hazards occurring to other people or their property.
- Never allow children or persons who are unfamiliar with this type of machine to use it, nor anyone who has not read this leaflet.
- Do not allow children, animals or other adults near your machine when in use - always keep them well away from the cutting area.



Care of your machine

- Store your machine in a dry place when not in use, out of the reach of children.
- Do not use solvents or cleaning fluids to clean your machine - use a blunt scraper to remove grass and dirt. Always disconnect from the electrical supply and ensure the cutting line (9) is stationary before cleaning.
- Do not operate your machine if any parts are defective.
- Do not attempt to remove any parts other than those mentioned in these instructions.
- Use only Black & Decker recommended replacement parts and accessories.

Electrical safety

Your machine should always be switched off at the mains before disconnecting any plug and socket connector, extension cables, or cordsets.

Mains plug replacement - UK only

Should your mains plug need replacing and you are competent to do this, proceed as instructed below. If you are in doubt contact a Black & Decker service centre or a qualified electrician.

- Disconnect the plug from the supply.
- Cut off the plug and dispose of it safely, a plug with bared copper conductors is dangerous if engaged in a live socket outlet.

- Only fit 13 amp BS1363A approved plugs fitted with the correctly rated fuse.
- The cable wire colours, or a letter, will be marked at the connection points of most good quality plugs. Attach the wires to their respective points in the plug (see below). Brown is for 'Live' (L) and blue is for 'Neutral' (N).

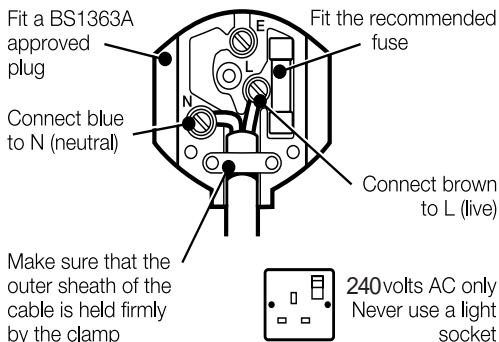

- Before replacing the top cover of the mains plug ensure that the cable restraint is holding the outer sheath of the cable firmly and that the two leads are correctly fixed at the terminal screws.
- **Warning!** Never connect Live or Neutral wires to Earth pin marked E or \perp .

Fuse replacement - UK only

Your machine is supplied with cable fitted with a non-wireable plug.

- The plug is fitted with a 5 amp fuse which is the recommended fuse for your machine.
- Only use replacement fuses which are approved to BS1362.
- When changing the fuse in your plug, always ensure the fuse cover is refitted. If the fuse cover is missing or damaged do not use the plug.

Note: Fuses do not give personal protection against electric shock.

Increased safety can be obtained by having a qualified electrician install a high sensitivity (30mA) circuit breaker in the house wiring. If you do not have such a circuit breaker installed, then we strongly recommend that the electrical power to the machine be supplied through a high sensitivity residual current device (RCD). The RCD is designed to provide a high degree of personal protection against harmful electric current should fault conditions occur.



Warning! The use of an RCD or other circuit breaker unit does not release the operator of the machine from the safety instructions and safe working practices given in this manual.

Extension cables or cordsets

You can use up to 30 metres (100ft) of extension cord without undue loss of power. Extension cords and cordsets should comply with national regulations.

Preparing the trimmer for use (Fig. 2)

2

- Take the trimmer and the guard (10) out of the box.
- Remove the guard screw (12) which is located on the underside of the guard (Fig. 2.1).
- Place the guard into the channel on the trimmer body (Fig. 2.2).
- Push the guard fully home until the guard is flush with the body (Fig. 2.3).
- Replace the guard screw (Fig. 2.4).
- If correctly assembled, the guard will now be secured to your trimmer.
- In transit, the end of the cutting line (9) is taped to the side of the spool cover. Please discard the tape to release the length of line. There should be a minimum of 9cm (3.5") of cutting line protruding from the spool housing before using your trimmer.

Note: When your machine is operated for the first time any excess line will be cut off by the line trimming blade (8) housed in the guard. This is also the case for any subsequent line adjustment. Because line cut off by the blade in the guard may be ejected, it is important that the amount of excess line is kept to a minimum. Where an excessive amount of line is pulled out, the line should be cut back to the outside of the guard before switching on your trimmer. Cut the line off on the trimmer blade by hand.

- Always ensure that the spool cover is secure before and after use.

How to use your trimmer (Fig. A - J)

In order to get the most from your trimmer please be sure to follow the techniques shown. Do not be impatient; you will obtain the best results through experience and by following these simple rules.

- A** Do not use your trimmer without its guard.
- B** Do not cut wet grass; best results are achieved when the grass is dry.

Trimming

- To switch on your trimmer, squeeze the trigger switch (3).
- To switch the unit off, release the trigger switch.
- To carry the trimmer when not in use, it is preferred that you use the secondary handle (2).

C Cut at an angle and with the tip of the cutting line (9).

D Swing the trimmer gently from side to side.

E Do not overload the trimmer. It operates best at high speeds.

F On long grass, start at the top and take small cuts.

G Use the edge of the guard (10) to keep the trimmer away from hard surfaces and delicate items.

Edging (GL540)

H Best results are achieved on edges greater than 50mm deep.

Note: Your trimmer is a maintenance tool for trimming overhanging grass and should not be used to create edges. Edges can be created using an edging spade.

J If your trimmer is for use with a 'detachable' cord, loop a length of cord through the cord restraint (5) to avoid the plug and socket coming apart accidentally, if the cord is pulled.

How to convert between the trimming and edging mode (Fig. 3)

In addition to conventional trimming, your trimmer can be used to trim overhanging grass along lawn edges and flower beds.

3 To convert your trimmer between the trimming and edging mode:

- With the trimmer switched off, place one hand on the switch handle (4) and the other on the trimmer body (1). Press the button (7) on the front of the trimmer body. Keeping the button depressed, rotate the trimmer body anti-clockwise and then release the button. Continue to rotate the trimmer body until it locks into position (Fig. 3.1).

- The most effective way to use your trimmer in edging mode is to stand by the side of it (Fig. 3.2). Guide the front edge of the trimmer (14) along the lawn so that the cutting line just trims the grass overhanging the lawn edge (Fig. H).

Replacement line

A new spool containing 10 metres of nylon line may be purchased from your Black & Decker dealer. Alternatively, replacement packs containing 25 to 50 metres of line are available.

For maximum reliability never put on a heavier or lighter line (eg. fishing line) which will prevent the automatic feed from functioning, cause motor failure or reduce cutting performance.

How to fit a new spool of cutting line (Fig. 4 & 5)

- Disconnect your trimmer from the power supply.
- 4**
- Remove the spool cover by pushing the 2 spool cover tabs (16) inwards and upwards (Fig. 4), then pull off (it is not necessary to push both tabs in at the same time). The empty spool can now be withdrawn from the drive shaft.
 - Remove any dirt or grass that may have collected inside the spool housing and cover.
 - Unwind approximately 9cm (3.5") of cutting line (9) from the new spool (19) and temporarily park the cutting line end in one of the 'L' shaped slots to prevent the line unravelling.
- 5**
- Feed the cutting line through the eyelet and then push the spool onto the centre drive shaft while pulling the free end of the line to release it from the 'L' shaped slot. To fully seat the spool, rotate as necessary, taking care not to trap the cutting line underneath the spool and making sure that there is a minimum of 9cm (3.5") protruding from the spool housing.
 - Replace the spool cover by aligning both tabs on it (16) with the slots in the spool housing and pushing them into place. Make sure that both tabs are securely located.

How to wind new line onto an empty spool (Fig. 6 & 7)

6

- A maximum of 10 metres of new cutting line can be wound onto the empty spool. The spool has an 'Indicator' to help you avoid winding an excessive quantity of cutting line on the spool, as too much will prevent the automatic feed system from functioning.
- Remove any remnant of old cutting line from the spool (19).
- Push the end of the new cutting line into one of the two retaining holes (21) provided in the spool (19) and insert 20mm.
- Bend the cutting line over, pulling it through the adjacent 'L' shaped slot. The cutting line should now be firmly anchored to the spool and you may proceed to wind it on in the direction of the arrow (20).
- Take time to wind the cutting line on neatly, in layers. Do not criss cross.
- When you have wound on sufficient cutting line, temporarily park it in one of the 'L' shaped slots to prevent the spool unravelling, ensuring you leave a minimum of 9cm (3.5") protruding.
- Fit the spool and spool cover (15) to the spool housing as described for fitting a new spool.

Care and maintenance

- For best performance, please keep the cutting line, spool and air slots in the trimmer body clean. Use a dry brush or cloth to remove grass, sap or other dirt.
- Plastic parts may be cleaned by using a mild soap and a cloth dampened with hot water. Do not use any type of detergent, cleaner or solvent which might contain chemicals which could seriously damage the plastic. Do not spray your trimmer with water.
- Self lubricating bearings are used in your trimmer, therefore, lubrication is not required.

Fault finding

Before checking your trimmer for any faults, disconnect it from the mains.

- If the trimmer will not start, check that the power cord is properly connected. If this does not work, check your power point. Finally, check the fuse and wiring on the cable extension plug (UK only).
- If the automatic line feed fails to operate, it could be for one of the following reasons:

Line too short or line jammed on spool

- Disconnect your trimmer from the power supply.
- Remove the spool cover (15) by pushing both tabs (16) inwards and upwards (Fig. 4).
- Lift the spool (19) approximately 6mm (1/4") from the spool housing (17), while pulling the cutting line (9). This will allow you to lengthen the line while clearing any line jammed inside the spool. Ensure there is a minimum of 9cm (3.5") protruding from the spool housing.
- Rotate the spool as necessary to fully seat the spool and replace the cover by aligning both tabs on the cover with the slots in the spool housing and push into place. Ensure that both tabs are securely located.

Line still jammed on spool or broken inside spool housing

- Disconnect the power supply and remove the cover, as previously described.
- Lift out the spool (19) completely, holding the coiled cutting line in place to prevent it unravelling from the spool (Fig. 7).
- Carefully unwind the cutting line (9) from the spool until any crossed or trapped loops are cleared. Rewind the cutting line evenly, in the direction of the arrow (20) on the spool.
- Temporarily park the cutting line end in one of the 'L' shaped slots to prevent the spool unravelling. Ensure you leave a minimum of 9cm (3-0") protruding.
- Turn the lever (22) backwards and forwards to ensure it operates freely.
- Remove any dirt or grass that may have collected inside the spool housing and cover.
- Feed the end of the line through the eyelet and then push the spool into the centre drive shaft while pulling the free end of the line to release it from the 'L' shaped slot. To fully seat the spool, rotate as necessary, taking care not to trap the line underneath the spool, and making sure that there is a minimum of 9cm (3.5") of line protruding from the spool housing.
- Finally, replace the cover as previously described.

Protecting the environment



Black & Decker provides a facility for recycling Black & Decker products once they have reached the end of their working life. This service is provided free of charge. To take advantage of this service please return your product to any authorised repair agent who will collect them on our behalf.

You can check the location of your nearest authorised repair agent by contacting your local Black & Decker office at the address indicated in this manual. Alternatively, a list of authorised Black & Decker repair agents and full details of our after-sales service and contacts are available on the Internet at: www.2helpU.com.

Guarantee

Black & Decker is confident of the quality of its products and offers an outstanding guarantee. This guarantee statement is in addition to and in no way prejudices your statutory rights. The guarantee is valid within the territories of the Member States of the European Union and the European Free Trade Area.

If a Black & Decker product becomes defective due to faulty materials, workmanship or lack of conformity, within 24 months from the date of purchase, Black & Decker guarantees to replace defective parts, repair products subjected to fair wear and tear or replace such products to ensure minimum inconvenience to the customer unless:

- The product has been used for trade, professional or hire purposes;
- The product has been subjected to misuse or neglect;
- The product has sustained damage through foreign objects, substances or accidents;
- Repairs have been attempted by persons other than authorised repair agents or Black & Decker service staff.

To claim on the guarantee, you will need to submit proof of purchase to the seller or an authorised repair agent. You can check the location of your nearest authorised repair agent by contacting your local Black & Decker office at the address indicated in this manual. Alternatively, a list of authorised Black & Decker repair agents and full details of our after-sales service and contacts are available on the Internet at: www.2helpU.com.

Other outdoor tools

Black & Decker has a full range of outdoor power tools that make life in the garden easy. If you would like further information on the following products, please contact our Service and Information Centre (see the address page towards the end of this manual) or your local Black & Decker retailer.

String trimmers
Chainsaws
Cordless shear
Hedgetrimmers
Lawnmowers
Lawnrakers
Leafbusters
Shredders

Not all products are available in all countries.

EC Declaration of conformity

GL544/GL545

Black & Decker declares that these tools conform to:

98/37/EC, 89/336/EEC, 73/23/EEC,
EN 55014, EN 60335, EN 61000,
2000/14/EC, Lawn trimmer, L ≤ 50 cm
Annex VIII, No. 0086

B.S.I., HP2 4SQ, United Kingdom

Level of sound pressure, measured according to 2000/14/EC:

L_{PA}	(sound pressure)	dB(A)	81
L_{WA}	(acoustic power)	dB(A)	94
L_{WA}	(guaranteed)	dB(A)	96

Hand/arm weighted vibration value according to EN 50144: 4 m/s²



Brian Cooke

Director of Engineering
Spennymoor, County Durham DL16 6JG,
United Kingdom
1-12-2001

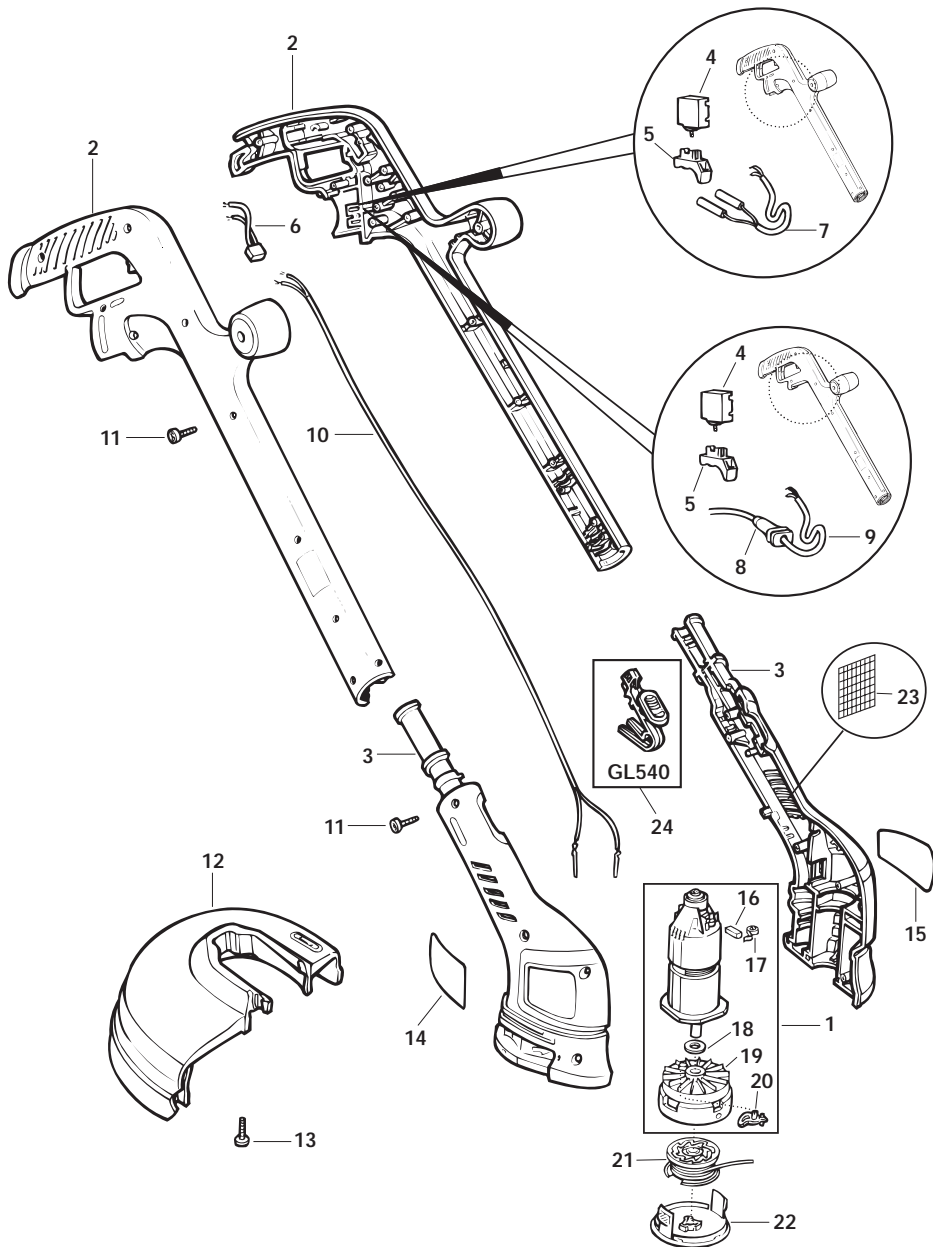

Australia

Black & Decker (Australia) Pty. Ltd. Tel. 03-8720 5100
20 Fletcher Road, Mooroolbark, Fax 03-9727 5940
Victoria, 3138

New Zealand

Black & Decker Tel. 09 579 7600
81 Hugo Johnston Drive Fax 09 579 8200
Penrose, Auckland, New Zealand

United Kingdom

Black & Decker Tel. 01753 511234
210 Bath Road Fax 01753 551155
Slough, Berkshire SL1 3YD Helpline 01753 574277